

Product Specification

SPECIFICATION FOR APPROVAL

- (●) Preliminary Specification
- () Final Specification

| | |
|-------|---------------------|
| Title | 24.0" WUXGA TFT LCD |
|-------|---------------------|

| | |
|-------|---------|
| BUYER | General |
| MODEL | |

| | |
|----------|----------------------|
| SUPPLIER | LG Display Co., Ltd. |
| *MODEL | LM240WU8 |
| SUFFIX | SLE1 |

*When you obtain standard approval,
please use the above model name without suffix

| APPROVED BY | SIGNATURE DATE |
|-------------|-------------------|
| / | _____ |
| / | _____ |
| / | _____ |

| APPROVED BY | SIGNATURE DATE |
|--------------------------|-------------------|
| W.G. Kweon / G.Manager | _____ |
| REVIEWED BY | |
| J.W. Hyun / Manager [C] | _____ |
| Y.S. Chung / Manager [M] | _____ |
| J.C. Yim / Manager [P] | _____ |
| PREPARED BY | |
| S.J. Yeom / Engineer | _____ |

Please return 1 copy for your confirmation with
your signature and comments.

Product Engineering Dept.
LG Display Co., Ltd

Product Specification
Contents

| No | ITEM | Page |
|-----------|---|-------------|
| | COVER | 1 |
| | CONTENTS | 2 |
| | RECORD OF REVISIONS | 3 |
| 1 | GENERAL DESCRIPTION | 4 |
| 2 | ABSOLUTE MAXIMUM RATINGS | 5 |
| 3 | ELECTRICAL SPECIFICATIONS | 6 |
| 3-1 | ELECTRICAL CHARACTERISTICS | 6 |
| 3-2 | INTERFACE CONNECTIONS | 9 |
| 3-3 | LVDS CHARACTERISTICS | 11 |
| 3-4 | SIGNAL TIMING SPECIFICATIONS | 13 |
| 3-5 | SIGNAL TIMING WAVEFORMS | 14 |
| 3-6 | COLOR INPUT DATA REFERENCE | 15 |
| 3-7 | POWER SEQUENCE & DIP CONDITION FOR LCD MODULE | 16 |
| 4 | OPTICAL SPECIFICATIONS | 18 |
| 5 | MECHANICAL CHARACTERISTICS | 24 |
| 6 | RELIABILITY | 27 |
| 7 | INTERNATIONAL STANDARDS | 28 |
| 7-1 | SAFETY | 28 |
| 7-2 | ENVIRONMENT | 28 |
| 8 | PACKING | 29 |
| 8-1 | DESIGNATION OF LOT MARK | 29 |
| 8-2 | PACKING FORM | 29 |
| 9 | PRECAUTIONS | 30 |
| 9-1 | MOUNTING PRECAUTIONS | 30 |
| 9-2 | OPERATING PRECAUTIONS | 30 |
| 9-3 | ELECTROSTATIC DISCHARGE CONTROL | 31 |
| 9-4 | PRECAUTIONS FOR STRONG LIGHT EXPOSURE | 31 |
| 9-5 | STORAGE | 31 |
| 9-6 | HANDLING PRECAUTIONS FOR PROTECTION FILM | 31 |

Product Specification

1. General Description

LM240WU8-SLE1 is a Color Active Matrix Liquid Crystal Display with a Light Emitting Diode (White LED) backlight system without LED driver. The matrix employs a-Si Thin Film Transistor as the active element. It is a transmissive type display operating in the normally black mode. It has a 24 inch diagonally measured active display area with WUXGA resolution (1200 vertical by 1920horizontal pixel array) Each pixel is divided into Red, Green and Blue sub-pixels or dots which are arranged in vertical stripes. Gray scale or the brightness of the sub-pixel color is determined with a 8-bit gray scale signal for each dot, thus, presenting a palette of more than 16,78M colors with A-FRC (Advanced Frame Rate Control). It has been designed to apply the 8Bit 2 port LVDS interface. It is intended to support displays where high brightness, super wide viewing angle, high color saturation, and high color are important._

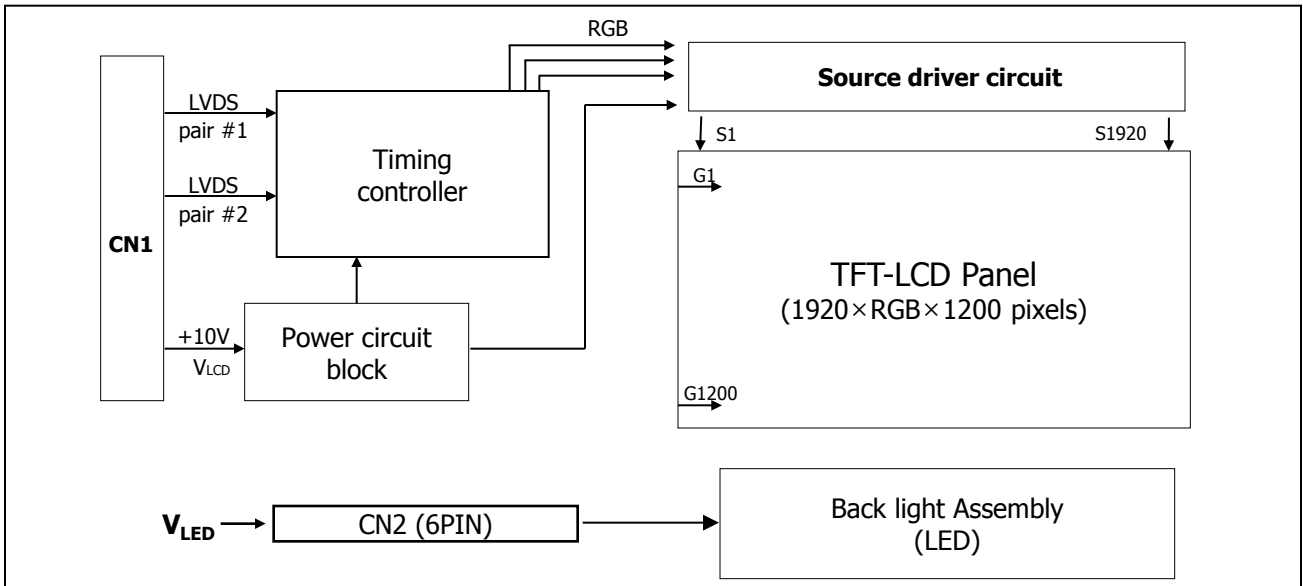

[Figure 1] Block diagram

General Features

| | |
|------------------------|--|
| Active Screen Size | 24.1 inches(61.13cm) diagonal (Aspect ratio 16:10) |
| Outline Dimension | 546.4(H) x 352.0(V) x 11.7(D) mm (Typ.) |
| Pixel Pitch | 0.270 mm x 0.270 mm |
| Pixel Format | 1920 horiz. By 1200 vert. Pixels RGB stripes arrangement |
| Color Depth | 16,78M colors (6bit + A-FRC) |
| Luminance, White | 300 cd/m ² (Center 1 Point, Typ.) |
| Viewing Angle(CR>10) | View Angle Free (R/L 178(Typ.), U/D 178(Typ.)) |
| Power Consumption | Total TBD Watt (Typ.) (TBD Watt @VLCD_mosaic, 12.2 Watt@Is=120mA) |
| Weight | TBD g (typ.) |
| Display Operating Mode | Transmissive mode, normally black |
| Module type | Non- borderless |
| Panel type | Forward |
| Surface Treatment | Anti-Glare treatment of the front polarizer (Haze25%, 3H) |

Product Specification

2. Absolute Maximum Ratings

The following are maximum values which, if exceeded, may cause faulty operation or damage to the unit.

Table 1. ABSOLUTE MAXIMUM RATINGS

| Parameter | Symbol | Values | | Units | Notes |
|-------------------------------------|----------------------|--------|------|-------|-------------|
| | | Min | Max | | |
| Power Input Voltage | V _{LCD} | -0.3 | 11.0 | Vdc | at 25 ± 2°C |
| Operating Temperature | T _{OP} | 0 | 50 | °C | 1, 2, 3 |
| Storage Temperature | T _{ST} | -20 | 60 | °C | |
| Operating Ambient Humidity | H _{OP} | 10 | 90 | %RH | |
| Storage Humidity | H _{ST} | 10 | 90 | %RH | |
| LCM Surface Temperature (Operation) | T _{Surface} | 0 | 65 | °C | 1, 4 |

- Note : 1. Temperature and relative humidity range are shown in the figure below.
 Wet bulb temperature should be 39 °C Max, and no condensation of water.
 2. Maximum Storage Humidity is up to 40 °C, 70% RH only for 4 corner light leakage Mura.
 3. Storage condition is guaranteed under packing condition
 4. LCM Surface Temperature should be Min. 0°C and Max. 65°C under the V_{LCD}=10.0V, f_V=60Hz, 25°C ambient Temp. no humidity control and LED string current is typical value.

FIG.2 Temperature and relative humidity

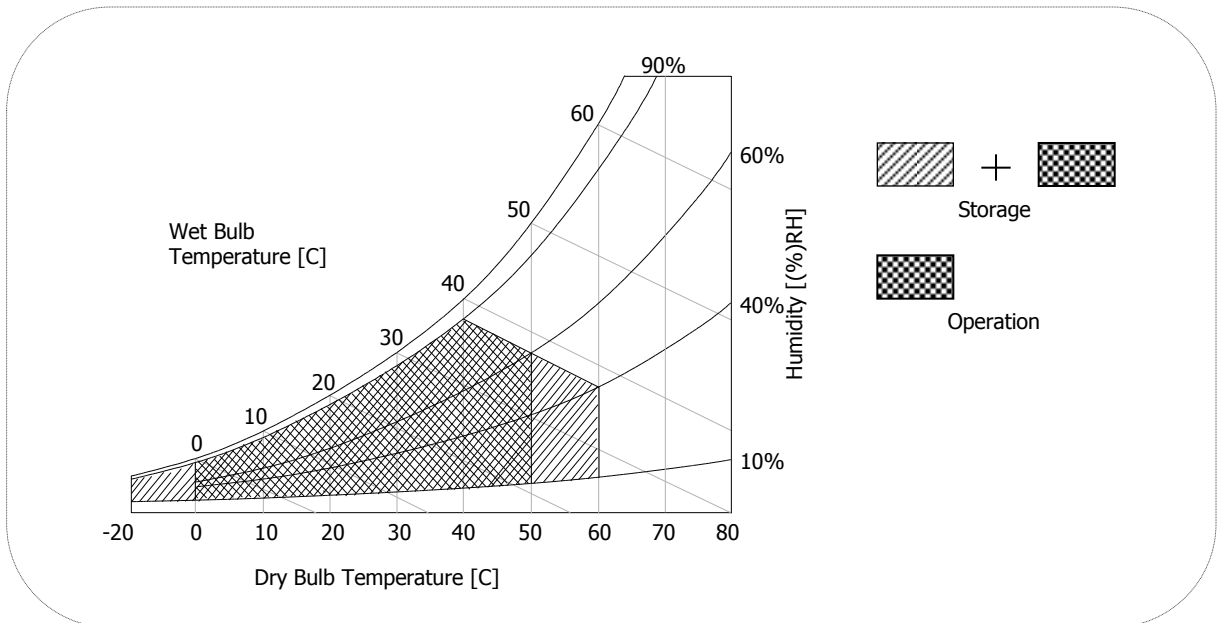

Product Specification

3. Electrical Specifications

3-1. Electrical Characteristics

It requires two power inputs. One is employed to power the LCD electronics and to drive the TFT array and liquid crystal. The second input power for the LED/Backlight, is typically generated by a LED Driver. The LED Driver is an external unit to the LCDs.

Table 2-1. ELECTRICAL CHARACTERISTICS

| Parameter | Symbol | Values | | | Unit | Notes |
|-------------------------------|-------------------------|--------|-----|------|------|-------|
| | | Min | Typ | Max | | |
| MODULE : | | | | | | |
| Power Supply Input Voltage | V _{LCD} | 9.5 | 10 | 10.5 | Vdc | |
| Permissive Power Input Ripple | V _{dRF} | | | 0.4 | V | 1 |
| Power Supply Input Current | I _{LCD_Mosaic} | - | TBD | TBD | mA | 2 |
| | I _{LCD_White} | - | TBD | TBD | mA | 3 |
| Power Consumption | P _{c_Mosaic} | - | TBD | TBD | Watt | 2 |
| | P _{cLCD_White} | - | TBD | TBD | Watt | 3 |
| Rush current | I _{RUSH} | - | - | 3.0 | A | 4 |

Note :

1. Permissive power ripple should be measured under V_{LCD} =10.0V, 25°C, fV(frame frequency)=MAX condition and At that time, we recommend the bandwidth configuration of oscilloscope is to be under 20Mhz. See the next page.
2. The specified current and power consumption are under the V_{LCD}=10.0V, 25± 2°C,fV=60Hz condition whereas Typical Power Pattern [Mosaic] shown in the [Figure 2] is displayed.
3. The current is specified at the maximum current pattern.
4. Maximum Condition of Inrush current :
The duration of rush current is about 5ms and rising time of power Input is 500us ± 20%.(min.).
5. VLCD level must be measured from LCM PCB's two points, between VIN and LCM Ground.
The measured level need to meet the Power supply input voltage spec.
(Test condition : maximum power pattern , 25± 2°C, fV=60Hz)

Product Specification

- **Permissive Power input ripple** ($V_{LCD} = 10V$, $25^{\circ}C$, f_v (frame frequency)=MAX condition)

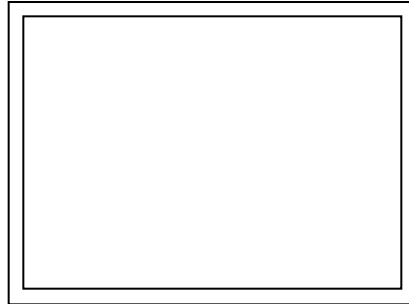

Full White Pattern

- **Power consumption** ($V_{LCD} = 10V$, $25^{\circ}C$, f_v (frame frequency)=60Hz condition)

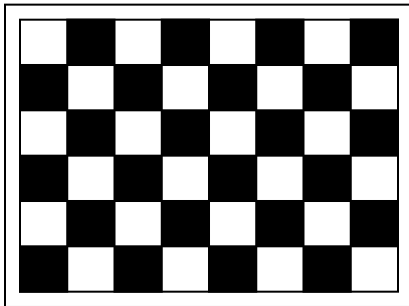

Typical power Pattern

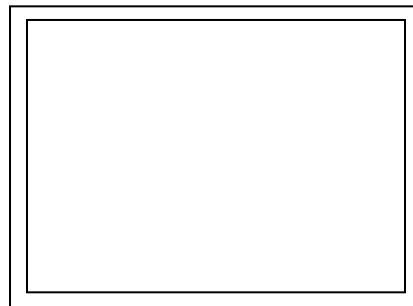

Maximum power Pattern

FIG.3 Mosaic pattern(8x6) & Full White Pattern for power consumption measurement

Product Specification
Table 2-2. LED Bar ELECTRICAL CHARACTERISTICS

| Parameter | Symbol | Values | | | Unit | Notes |
|--------------------|------------------|--------|--------|--------|------|---------|
| | | Min. | Typ. | Max. | | |
| LED String Current | Is | - | (120) | (125) | mA | 1, 2, 5 |
| LED String Voltage | Vs | (47.6) | (51.0) | (54.4) | V | 1, 5 |
| Power Consumption | P _{Bar} | - | (12.2) | (13.1) | Watt | 1, 2, 4 |
| LED Life Time | LED_LT | 30,000 | - | - | Hrs | 3 |

Notes) The LED Bar consists of 34 LED packages, 2 strings (parallel) x 17 packages (serial)

LED driver design guide

: The design of the LED driver must have specifications for the LED in LCD Assembly.

The performance of the LED in LCM, for example life time or brightness, is extremely influenced by the characteristics of the LED driver.

So all the parameters of an LED driver should be carefully designed and output current should be Constant current control.

Please control feedback current of each string individually to compensate the current variation among the strings of LEDs.

When you design or order the LED driver, please make sure unwanted lighting caused by the mismatch of the LED and the LED driver (no lighting, flicker, etc) never occurs.

When you confirm it, the LCD module should be operated in the same condition as installed in your instrument.

1. Specified values are for a single LED bar.
2. The specified current is defined as the input current for a single LED string with 100% duty cycle.
3. The LED life time is defined as the time when brightness of LED packages become 50% or less than the initial value under the conditions at $T_a = 25 \pm 2^\circ\text{C}$ and LED string current is typical value.
4. The power consumption shown above does not include loss of external driver.
 The typical power consumption is calculated as $P_{\text{Bar}} = V_s(\text{Typ.}) \times I_s(\text{Typ.}) \times \text{No. of strings}$.
 The maximum power consumption is calculated as $P_{\text{Bar}} = V_s(\text{Max.}) \times I_s(\text{Typ.}) \times \text{No. of strings}$.
5. LED operating conditions are must not exceed Max. ratings.

Product Specification

3-2. Interface Connections

3-2-1. LCD Module

- LCD Connector(CN1) : GT103-30S-H23-D (LSM), KDF71G-30S-1H(Hirose) or Equivalent
- Mating Connector : FI-X30C2L (Manufactured by JAE) or Equivalent

Table 3. MODULE CONNECTOR(CN1) PIN CONFIGURATION

| No | Symbol | Description | No | Symbol | Symbol |
|----|---------|--|----|---------|--|
| 1 | FR0M | Minus signal of odd channel 0 (LVDS) | 16 | SR1P | Plus signal of even channel 1 (LVDS) |
| 2 | FR0P | Plus signal of odd channel 0 (LVDS) | 17 | GND | Ground |
| 3 | FR1M | Minus signal of odd channel 1 (LVDS) | 18 | SR2M | Minus signal of even channel 2 (LVDS) |
| 4 | FR1P | Plus signal of odd channel 1 (LVDS) | 19 | SR2P | Plus signal of even channel 2 (LVDS) |
| 5 | FR2M | Minus signal of odd channel 2 (LVDS) | 20 | SCLKINM | Minus signal of even clock channel (LVDS) |
| 6 | FR2P | Plus signal of odd channel 2 (LVDS) | 21 | SCLKINP | Plus signal of even clock channel (LVDS) |
| 7 | GND | Ground | 22 | SR3M | Minus signal of even channel 3 (LVDS) |
| 8 | FCLKINM | Minus signal of odd clock channel (LVDS) | 23 | SR3P | Plus signal of even channel 3 (LVDS) |
| 9 | FCLKINP | Plus signal of odd clock channel (LVDS) | 24 | GND | Ground |
| 10 | FR3M | Minus signal of odd channel 3 (LVDS) | 25 | NC | No Connection (I2C Serial interface for LCM) |
| 11 | FR3P | Plus signal of odd channel 3 (LVDS) | 26 | NC | No Connection.(I2C Serial interface for LCM) |
| 12 | SR0M | Minus signal of even channel 0 (LVDS) | 27 | ITLC | Interlace Mode Selection 'H'(3.3V) = Enable , 'L' = Disable |
| 13 | SR0P | Plus signal of even channel 0 (LVDS) | 28 | VLCD | Power Supply +10.0V |
| 14 | GND | Ground | 29 | VLCD | Power Supply +10.0V |
| 15 | SR1M | Minus signal of even channel 1 (LVDS) | 30 | VLCD | Power Supply +10.0V |

- Notes :
1. All GND(ground) pins should be connected together to the LCD module's metal frame.
 2. All VLCD (power input) pins should be connected together.
 3. All Input levels of LVDS signals are based on the EIA 644 Standard.
 4. PWM_OUT is a reference signal for LED PWM control. This PWM signal is synchronized with vertical frequency. Its frequency is 5 times of vertical frequency, and its duty ratio is 50%.
If the system don't use this pin, do not connect.

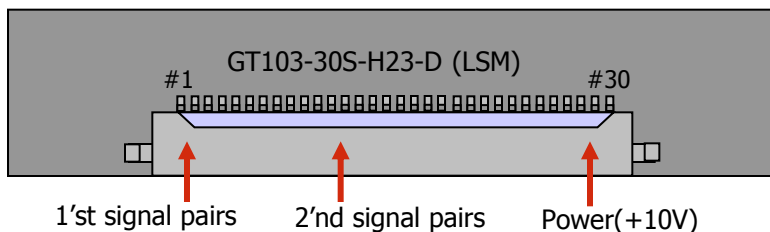

FIG.4 Connector diagram

Product Specification

3-2-2. BACKLIGHT CONNECTOR PIN CONFIGURATION(CN2)

The LED interface connector is a model SM06B-SHJH(HF)_Manufactured by JST or equivalent.
The mating connector is a SHJP-06V-S(HF), SHJP-06V-A-K(HF) or equivalent.
The pin configuration for the connector is shown in the table below.

| Pin | Symbol | Description | Notes |
|-----|--------|---------------------------|-------|
| 1 | FB1 | Channel1 Current Feedback | |
| 2 | NC | No connection | |
| 3 | VLED | LED Power Supply | |
| 4 | VLED | LED Power Supply | |
| 5 | NC | No connection | |
| 6 | FB2 | Channel2 Current Feedback | |

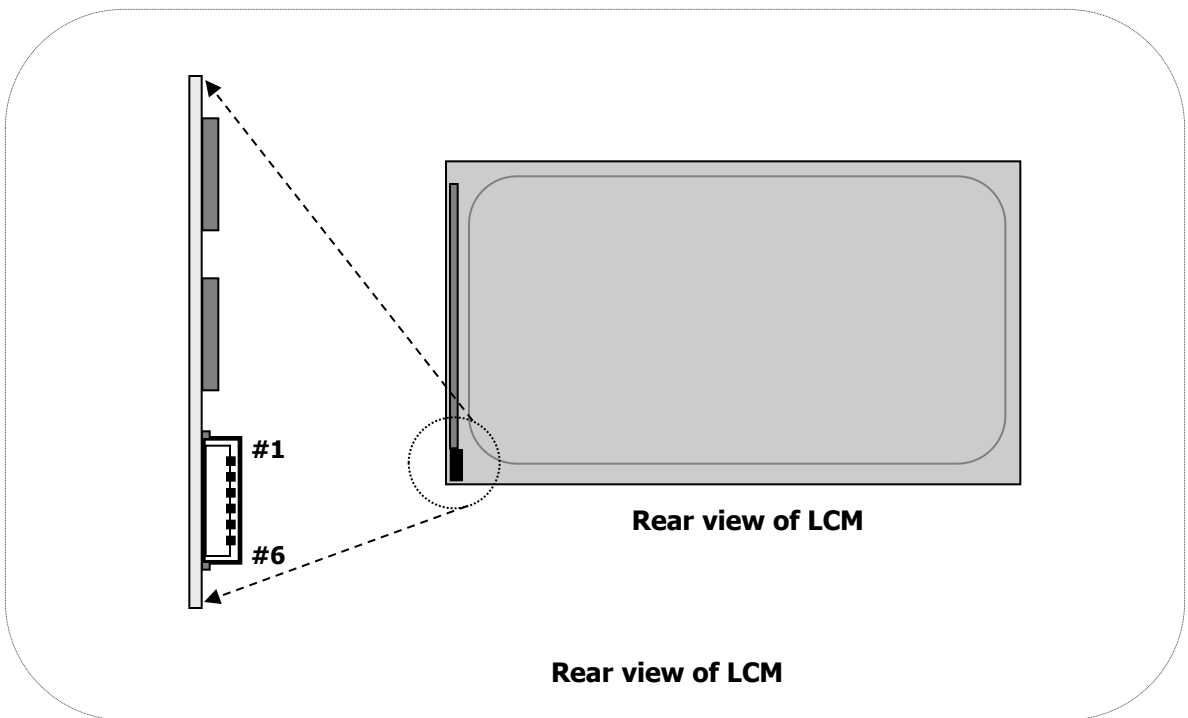

[Figure 3] Backlight connector view

Product Specification

3-3. LVDS characteristics

3-3-1. DC Specification

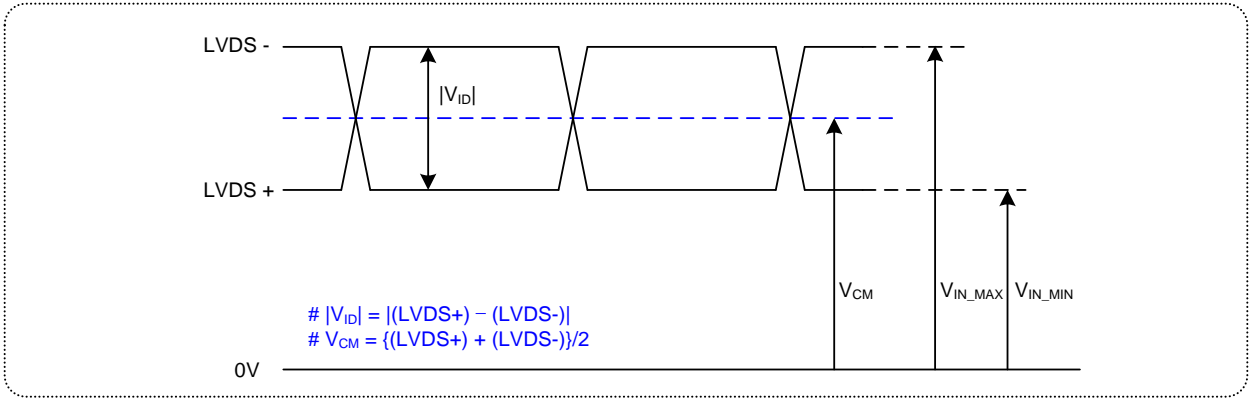

| Description | Symbol | Min | Max | Unit | Notes |
|-------------------------------|-----------------|-----|-----|------|-------|
| LVDS Differential Voltage | $ V_{ID} $ | 150 | 600 | mV | - |
| LVDS Common mode Voltage | V_{CM} | 1.0 | 1.5 | V | - |
| LVDS Input Voltage Range | V_{IN} | 0.7 | 1.8 | V | - |
| Change in common mode Voltage | ΔV_{CM} | - | 250 | mV | - |

Notes : Dose not have any Noise & Peaking in LVDS Signal

3-3-2. AC Specification

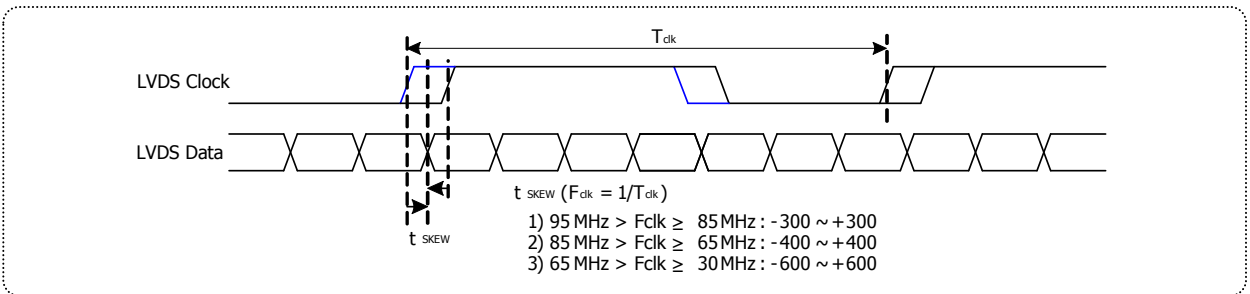

| Description | Symbol | Min | Max | Unit | Notes |
|---|----------------|-------|-------|-----------|----------------------|
| LVDS Clock to Data Skew Margin | t_{SKEW} | - 300 | + 300 | ps | 95MHz > Fclk ≥ 85MHz |
| | t_{SKEW} | - 400 | + 400 | ps | 85MHz > Fclk ≥ 65MHz |
| | t_{SKEW} | - 600 | + 600 | ps | 65MHz > Fclk ≥ 30MHz |
| LVDS Clock to Clock Skew Margin (Even to Odd) | t_{SKEW_EO} | - 1/7 | + 1/7 | T_{clk} | - |

Note 1 :

LGD recommend the SI should be adjust the SSC deviation and modulation frequency in order not to happen any kinds of defect phenomenon.

Product Specification

3-3-2. AC Specification

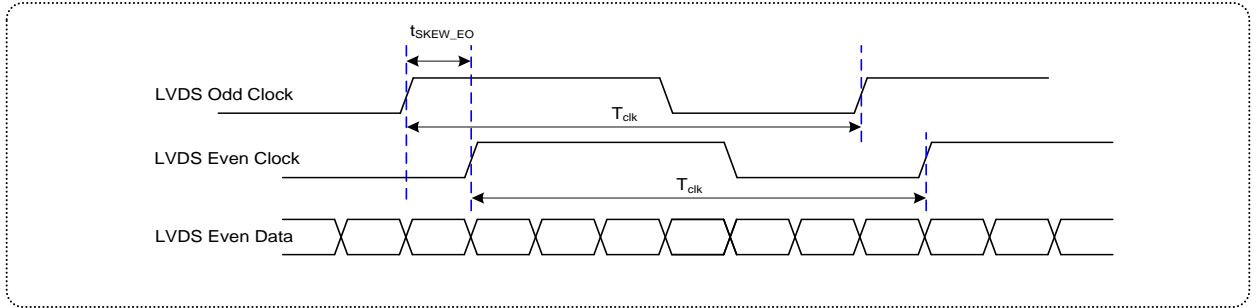

< Clock skew margin between channel >

3-3-3. LVDS data format(8bit,VESA)

1) LVDS 2 Port

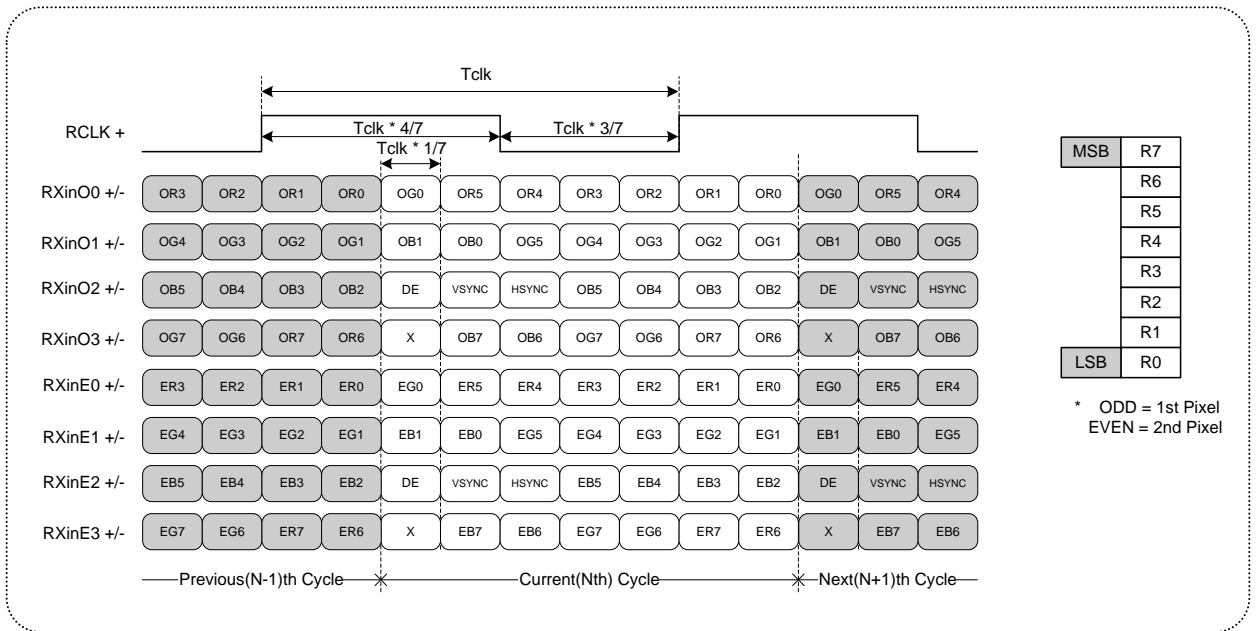

< LVDS Data Format >

Product Specification
3-4. Signal Timing Specifications

This is signal timing required at the input of the TMDS transmitter. All of the interface signal timing should be satisfied with the following specifications for it's proper operation.

Table 4. TIMING TABLE

| ITEM | Symbol | | Min | Typ | Max | Unit | Note |
|-------|------------------|------|-------|-------|-------|------|----------------------------------|
| DCLK | Period | tCLK | 12.19 | 12.98 | 16.06 | ns | Pixel frequency : Typ. 154MHz |
| | Frequency | fCLK | 62.24 | 77 | 82 | MHz | |
| Hsync | Period | tHP | 1013 | 1040 | 1048 | tCLK | |
| | Horizontal Valid | tHV | 960 | 960 | 960 | tCLK | |
| | Horizontal Blank | tHB | 53 | 80 | 88 | | |
| | Frequency | fH | 61.13 | 74.1 | 81 | KHz | |
| Vsync | Period | tVP | 1229 | 1235 | 1390 | tHP | |
| | Vertical Valid | tVW | 1200 | 1200 | 1200 | tHP | |
| | Vertical Blank | tVB | 29 | 35 | 190 | tHP | |
| | Frequency | fV | 49.5 | 60 | 61 | Hz | |

Note: Hsync period and Hsync width-active should be even number times of tCLK.

If the value is odd number times of tCLK, display control signal can be asynchronous.

In order to operate this LCM a Hsync, Vsync, and DE(data enable) signals should be used.

1. The Input of Hsync & Vsync signal does not have an effect on normal operation (DE Only Mode). If you use spread spectrum for EMI, add some additional clock to minimum value for clock margin.
2. The performance of the electro-optical characteristics may be influenced by variance of the vertical refresh rates.
3. Vsync and Hsync should be keep the above specification.
4. Hsync Period, Hsync Width, and Horizontal Back Porch should be any times of character number(4).
5. The polarity of Hsync, Vsync is not restricted.

3-5. Signal Timing Waveforms

1. DCLK, DE, DATA waveforms

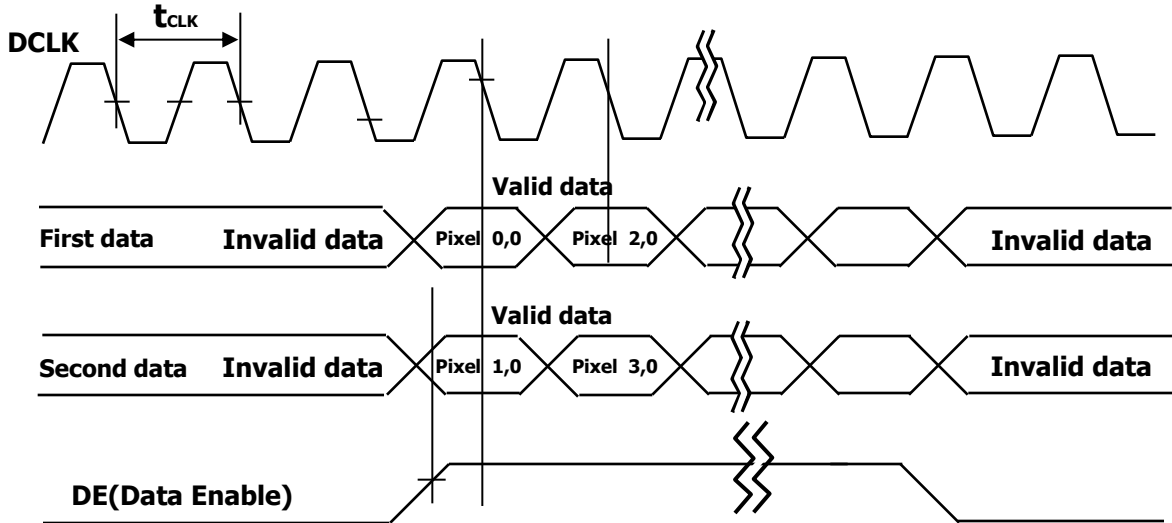

2. Horizontal waveform

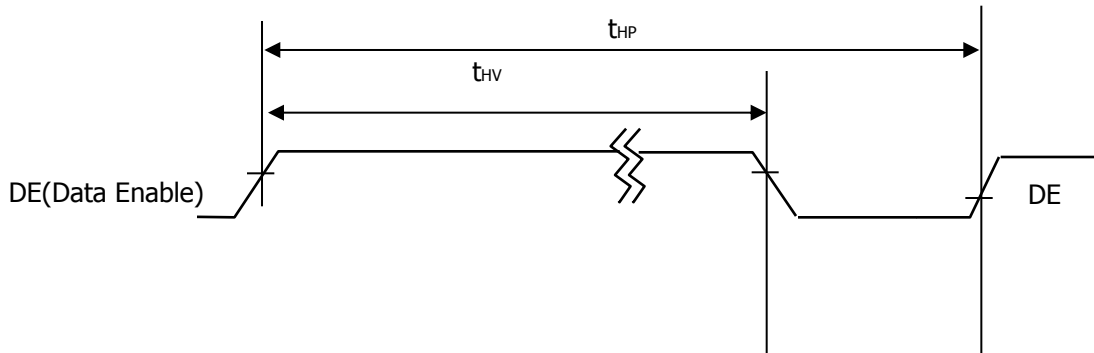

3. Vertical waveform

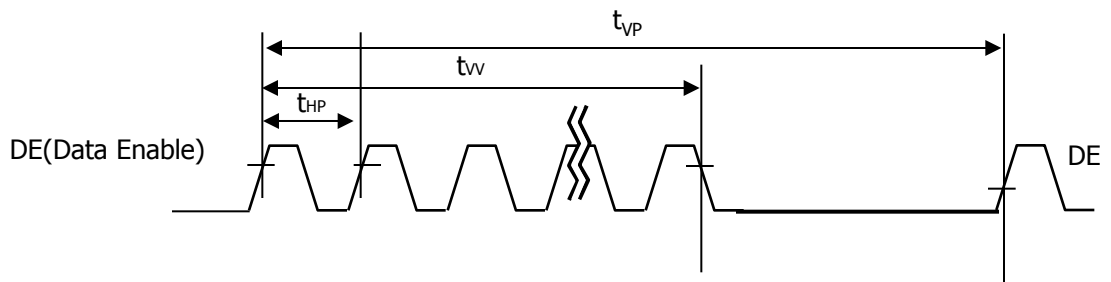

Product Specification
3-6. Color Input Data Reference

The Brightness of each primary color(red,green,blue) is based on the 8-bit gray scale data input for the color; the higher the binary input, the brighter the color. The table below provides a reference for color versus data input.

Table 5. COLOR DATA REFERENCE

| Color | | Input Color Data | | | | | | | | | | | | | | | | | | | | | | | |
|-------------|------------------|------------------|----|----|----|----|----|----|-----|-------|----|----|----|----|----|----|-----|------|----|----|----|----|----|----|-----|
| | | RED | | | | | | | | GREEN | | | | | | | | BLUE | | | | | | | |
| | | MSB | | | | | | | LSB | MSB | | | | | | | LSB | MSB | | | | | | | LSB |
| | | R7 | R6 | R5 | R4 | R3 | R2 | R1 | R0 | G7 | G6 | G5 | G4 | G3 | G2 | G1 | G0 | B7 | B6 | B5 | B4 | B3 | B2 | B1 | B0 |
| Basic Color | Black | 0 | 0 | 0 | 0 | 0 | 0 | 0 | 0 | 0 | 0 | 0 | 0 | 0 | 0 | 0 | 0 | 0 | 0 | 0 | 0 | 0 | 0 | 0 | 0 |
| | Red (255) | 1 | 1 | 1 | 1 | 1 | 1 | 1 | 1 | 0 | 0 | 0 | 0 | 0 | 0 | 0 | 0 | 0 | 0 | 0 | 0 | 0 | 0 | 0 | 0 |
| | Green (255) | 0 | 0 | 0 | 0 | 0 | 0 | 0 | 0 | 1 | 1 | 1 | 1 | 1 | 1 | 1 | 1 | 0 | 0 | 0 | 0 | 0 | 0 | 0 | 0 |
| | Blue (255) | 0 | 0 | 0 | 0 | 0 | 0 | 0 | 0 | 0 | 0 | 0 | 0 | 0 | 0 | 0 | 0 | 1 | 1 | 1 | 1 | 1 | 1 | 1 | 1 |
| | Cyan | 0 | 0 | 0 | 0 | 0 | 0 | 0 | 0 | 1 | 1 | 1 | 1 | 1 | 1 | 1 | 1 | 1 | 1 | 1 | 1 | 1 | 1 | 1 | 1 |
| | Magenta | 1 | 1 | 1 | 1 | 1 | 1 | 1 | 1 | 0 | 0 | 0 | 0 | 0 | 0 | 0 | 0 | 1 | 1 | 1 | 1 | 1 | 1 | 1 | 1 |
| | Yellow | 1 | 1 | 1 | 1 | 1 | 1 | 1 | 1 | 1 | 1 | 1 | 1 | 1 | 1 | 1 | 1 | 0 | 0 | 0 | 0 | 0 | 0 | 0 | 0 |
| | White | 1 | 1 | 1 | 1 | 1 | 1 | 1 | 1 | 1 | 1 | 1 | 1 | 1 | 1 | 1 | 1 | 1 | 1 | 1 | 1 | 1 | 1 | 1 | 1 |
| RED | RED (000) Dark | 0 | 0 | 0 | 0 | 0 | 0 | 0 | 0 | 0 | 0 | 0 | 0 | 0 | 0 | 0 | 0 | 0 | 0 | 0 | 0 | 0 | 0 | 0 | 0 |
| | RED (001) | 0 | 0 | 0 | 0 | 0 | 0 | 0 | 1 | 0 | 0 | 0 | 0 | 0 | 0 | 0 | 0 | 0 | 0 | 0 | 0 | 0 | 0 | 0 | 0 |
| | ... | ... | | | | | | | | ... | | | | | | | | ... | | | | | | | |
| | RED (254) | 1 | 1 | 1 | 1 | 1 | 1 | 1 | 0 | 0 | 0 | 0 | 0 | 0 | 0 | 0 | 0 | 0 | 0 | 0 | 0 | 0 | 0 | 0 | 0 |
| | RED (255) | 1 | 1 | 1 | 1 | 1 | 1 | 1 | 1 | 0 | 0 | 0 | 0 | 0 | 0 | 0 | 0 | 0 | 0 | 0 | 0 | 0 | 0 | 0 | 0 |
| GREEN | GREEN (000) Dark | 0 | 0 | 0 | 0 | 0 | 0 | 0 | 0 | 0 | 0 | 0 | 0 | 0 | 0 | 0 | 0 | 0 | 0 | 0 | 0 | 0 | 0 | 0 | 0 |
| | GREEN (001) | 0 | 0 | 0 | 0 | 0 | 0 | 0 | 0 | 0 | 0 | 0 | 0 | 0 | 0 | 1 | 0 | 0 | 0 | 0 | 0 | 0 | 0 | 0 | |
| | ... | ... | | | | | | | | ... | | | | | | | | ... | | | | | | | |
| | GREEN (254) | 0 | 0 | 0 | 0 | 0 | 0 | 0 | 0 | 1 | 1 | 1 | 1 | 1 | 1 | 0 | 0 | 0 | 0 | 0 | 0 | 0 | 0 | 0 | |
| | GREEN (255) | 0 | 0 | 0 | 0 | 0 | 0 | 0 | 0 | 1 | 1 | 1 | 1 | 1 | 1 | 1 | 0 | 0 | 0 | 0 | 0 | 0 | 0 | 0 | |
| BLUE | BLUE (000) Dark | 0 | 0 | 0 | 0 | 0 | 0 | 0 | 0 | 0 | 0 | 0 | 0 | 0 | 0 | 0 | 0 | 0 | 0 | 0 | 0 | 0 | 0 | 0 | |
| | BLUE (001) | 0 | 0 | 0 | 0 | 0 | 0 | 0 | 0 | 0 | 0 | 0 | 0 | 0 | 0 | 0 | 0 | 0 | 0 | 0 | 0 | 0 | 0 | 1 | |
| | ... | ... | | | | | | | | ... | | | | | | | | ... | | | | | | | |
| | BLUE (254) | 0 | 0 | 0 | 0 | 0 | 0 | 0 | 0 | 0 | 0 | 0 | 0 | 0 | 0 | 0 | 1 | 1 | 1 | 1 | 1 | 1 | 1 | 0 | |
| | BLUE (255) | 0 | 0 | 0 | 0 | 0 | 0 | 0 | 0 | 0 | 0 | 0 | 0 | 0 | 0 | 0 | 1 | 1 | 1 | 1 | 1 | 1 | 1 | 1 | |

Product Specification

3-7. Power Sequence

3-7-1. Power Sequence

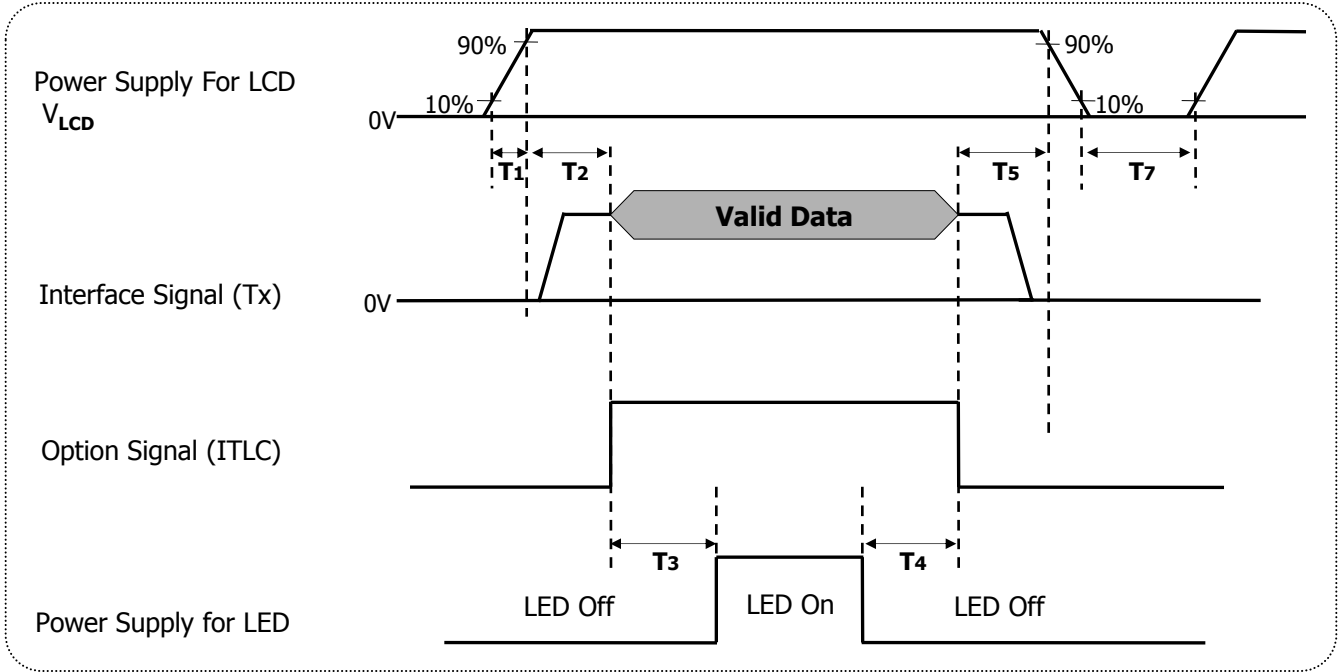

Table 6. POWER SEQUENCE

| Parameter | Values | | | Units |
|-----------|--------|-----|-----|-------|
| | Min | Typ | Max | |
| T1 | 0.5 | - | 10 | ms |
| T2 | 0.01 | - | 50 | ms |
| T3 | 500 | - | - | ms |
| T4 | 200 | - | - | ms |
| T5 | 0.01 | - | 50 | ms |
| T7 | 1000 | - | - | ms |

- Notes :
1. Please VLCD power on only after connecting interface cable to LCD.
 2. Please avoid floating state of interface signal at invalid period.
 3. When the interface signal is invalid, be sure to pull down the power supply for LCD V_{LCD} to 0V.
 4. The invalid signal means out of the signal timing specification which define as page 17.
 5. The above power sequence should be satisfied the basic power on/off and resolution, timing transition.
 6. LED power must be turn on after power supply for LCD and interface signal are valid.
 7. Recommend to follow Power sequence at these case
 - .AC/DC Power On/Off
 - .Mode change (Resolution, frequency, timing, sleep mode, Color depth change, etc.)
 If not to follow power sequence, there is a risk of abnormal display.

3-7-2. V_{LCD} Power Dip Condition

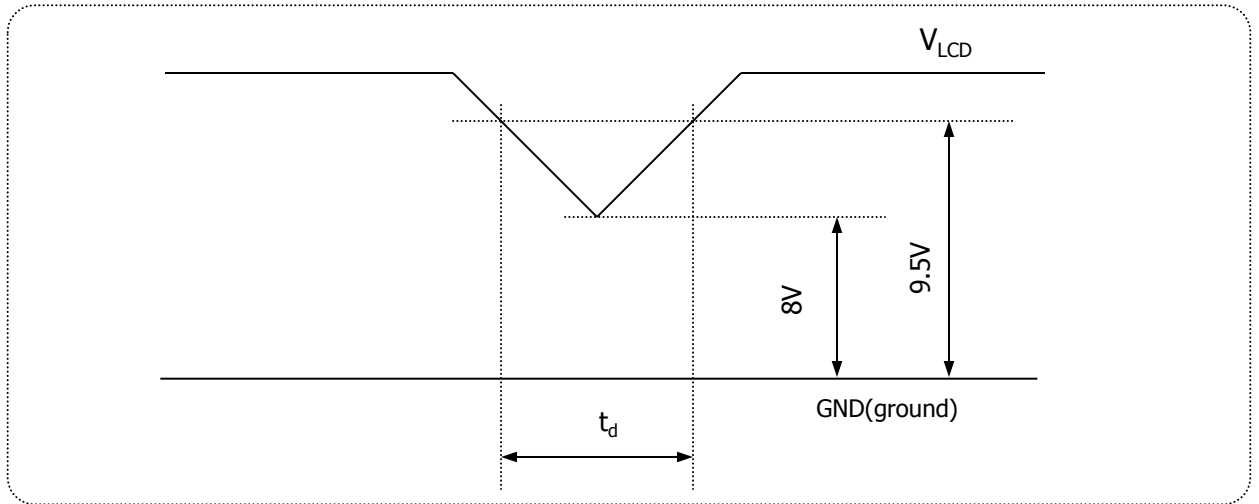

FIG.5 Power dip condition

1) Dip condition

$$8V \leq V_{LCD} < 9.5V, t_d \leq 20ms$$

2) $V_{LCD} < 8V$

V_{LCD} -dip conditions should also follow the Power On/Off conditions for supply voltage.

Product Specification
4. Optical Specifications

Optical characteristics are determined after the unit has been 'ON' for approximately 30 minutes in a dark environment at $25 \pm 2^\circ\text{C}$. The values specified are at an approximate distance 50cm from the LCD surface at a viewing angle of Φ and θ equal to 0° and aperture 1 degree.

FIG. 4 presents additional information concerning the measurement equipment and method.

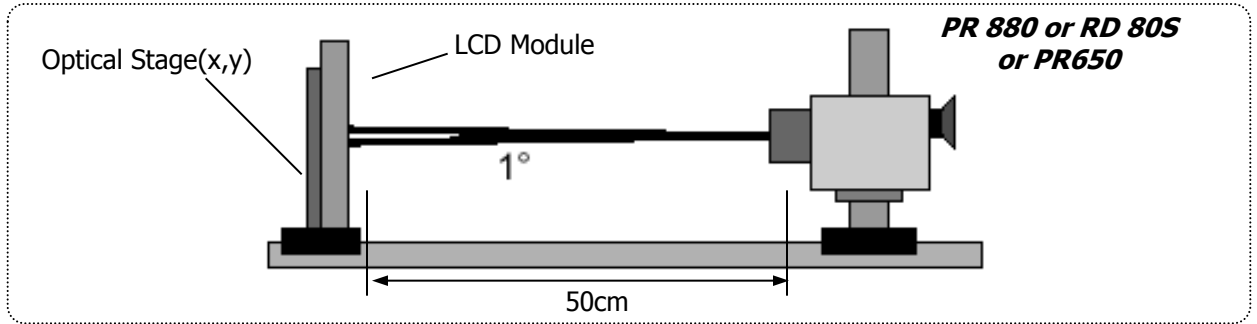
FIG.4 Optical Characteristic Measurement Equipment and Method
Table 7. OPTICAL CHARACTERISTICS

($T_a = 25^\circ\text{C}$, $V_{LCD} = 10\text{V}$, $f_v = 60\text{Hz}$ Dclk=154MHz, $I_{BL} = 80\text{mA}$)

| Parameter | Symbol | Values | | | Units | Notes | |
|---|------------------|---------------------|--------------|-------|-------------------|--------|---|
| | | Min | Typ | Max | | | |
| Contrast Ratio | CR | 700 | 1000 | - | | 1 | |
| Surface Luminance, white | L_{WH} | 250 | 300 | - | cd/m ² | 2 | |
| Luminance Variation | δ_{WHITE} | 75 | - | - | % | 3 | |
| Response Time | Gray To Gray | T_{GTG_AVR} | - | 14 | 28 | ms | 4 |
| Color Coordinates [CIE1931] <i>(By PR650)</i> | RED | Rx | | TBD | | | |
| | | Ry | | TBD | | | |
| | GREEN | Gx | | TBD | | | |
| | | Gy | Typ -0.03 | TBD | Typ +0.03 | | |
| | BLUE | Bx | | TBD | | | |
| | | By | | TBD | | | |
| | WHITE | Wx | | 0.313 | | | |
| | Wy | | 0.329 | | | | |
| Color Shift (Avg. $\Delta u'v' < 0.02$) | Horizontal | θ_{CST_H} | - | 140 | - | Degree | 5 |
| | Vertical | θ_{CST_V} | - | 100 | - | | |
| Viewing Angle (CR>10) | | | | | | | |
| General | Horizontal | θ_H | 170 | 178 | - | Degree | 6 |
| | Vertical | θ_V | 170 | 178 | - | | |
| GSR @ 60dgree (Gamma shift rate) | Horizontal | δ_{Gamma_H} | - | - | 20 | % | 7 |
| | Vertical | δ_{Gamma_V} | - | - | 20 | | |
| Gray Scale | | - | | 2.2 | | 8 | |

Product Specification

Notes 1. **Contrast Ratio(CR)** is defined mathematically as : **(By PR880)**

$$\text{Contrast Ratio} = \frac{\text{Surface Luminance with all white pixels}}{\text{Surface Luminance with all black pixels}}$$

It is measured at center point(Location P1)

2. **Surface luminance(L_{WH})** is luminance value at Center 1 point(P1) across the LCD surface 50cm from the surface with all pixels displaying white. For more information see FIG.8 (By PR880)

3. The **variation in surface luminance** , δ WHITE is defined as : **(By PR880)**

$$\delta_{\text{WHITE}} = \frac{\text{Minimum}(L_{P1}, L_{P2}, \dots, L_{P9})}{\text{Maximum}(L_{P1}, L_{P2}, \dots, L_{P9})} \times 100$$

Where L1 to L9 are the luminance with all pixels displaying white at 9 locations.
 For more information see FIG.8

4. **Gray to gray response time** is the time required for the display to transition from gray to gray.
 For additional information see Table 9. **(By RD80S)**

5. **Color shift** is the angle at which the average color difference for all Macbeth is lower than 0.02.
 For more information see FIG.9 **(By EZ Contrast)**
 - Color difference (Δu'v')

$$u' = \frac{4x}{-2x + 12y + 3} \quad v' = \frac{9y}{-2x + 12y + 3} \quad \Delta u'v' = \sqrt{(u'_1 - u'_2)^2 + (v'_1 - v'_2)^2}$$

$$\text{Avg}(\Delta u'v') = \frac{\sum_{i=1}^{24} (\Delta u'v')_i}{24}$$

u'1, v'1 : u'v' value at viewing angle direction
 u'2, v'2 : u'v' value at front (θ=0)
 i : Macbeth chart number (Define 23 page)

- Pattern size : 25% Box size
- Viewing angle direction of color shift : Horizontal, Vertical

6. **Viewing angle** is the angle at which the contrast ratio is greater than 10. The angles are determined for the horizontal or x axis and the vertical or y axis with respect to the z axis which is normal to the LCD surface. For more information see FIG.10 **(By PR880)**

7. **GSR** is the rate of gamma shift at up, down, left and right 60 degree viewing angle compare with center gamma. For more information see FIG.11 and FIG.12 **(By EZ Contrast)**
 - GSR (δ_{Gamma}) is defined as :

$$\text{GSR} = \left(1 - \frac{\text{View angle Gamma Value (Up, Down, Left, Right 60 Degree)}}{\text{Center Gamma Value (0 Degree)}} \right) \times 100$$

Product Specification

Notes 8. Gamma Value is approximately 2.2. For more information see Table 10.

Measuring point for surface luminance & measuring point for luminance variation.

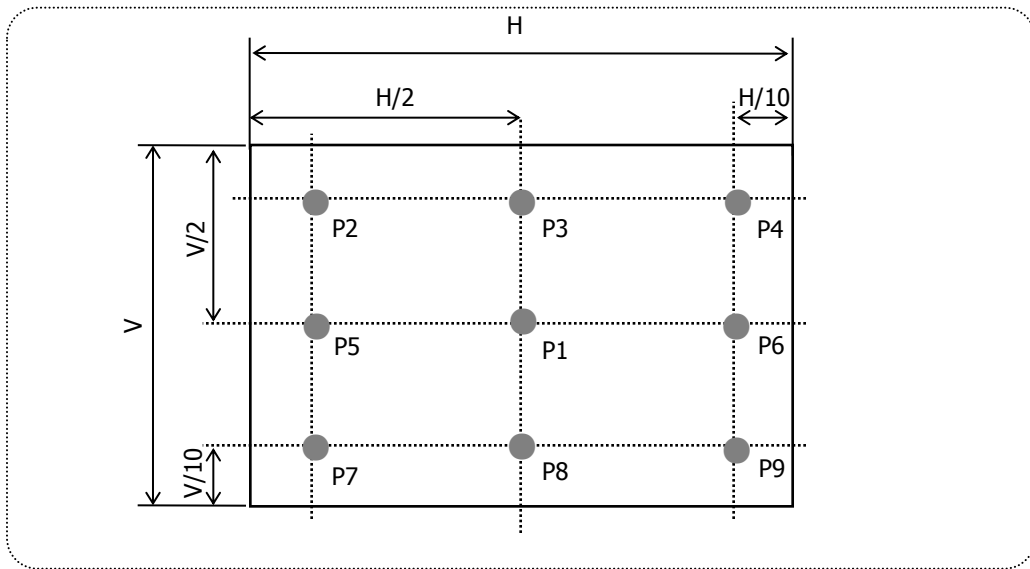

FIG.8 Measure Point for Luminance

The Gray to Gray response time is defined as the following figure and shall be measured by switching the input signal for "Gray To Gray".

- Gray step : 5 Step
- TGTG_AVR is the total average time at rising time and falling time for "Gray To Gray".
- if system use ODC (Over Driving Circuit) function, Gray to Gary response time may be 5ms~8ms GtG
- * it depends on Overshoot rate.

Table 8. GTG Gray Table

| Gray to Gray | | Rising Time | | | | |
|--------------|------|-------------|------|------|-----|----|
| | | G255 | G191 | G127 | G63 | G0 |
| Falling Time | G255 | | | | | |
| | G191 | | | | | |
| | G127 | | | | | |
| | G63 | | | | | |
| | G0 | | | | | |

Product Specification

G to G(BW) Response time is defined as the following figure and shall be measured by switching the input signal for "Gray(N)" and "Black or White".

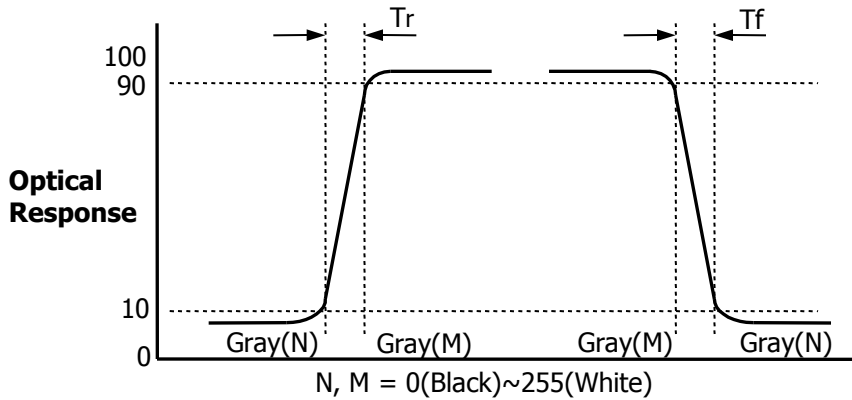

Color shift is defined as the following test pattern and color.

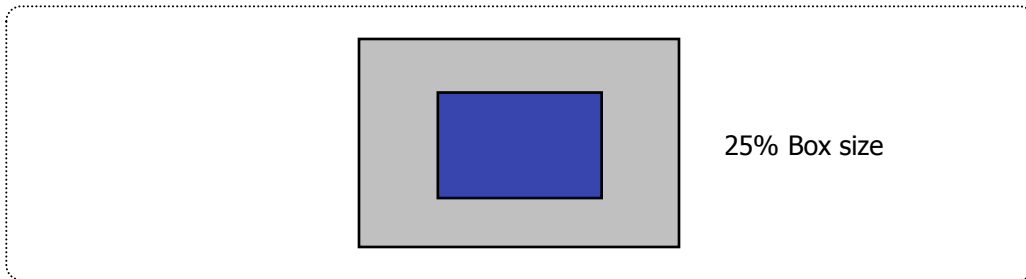

FIG.9 Color Shift Test Pattern

Average RGB values in Bruce RGB for Macbeth Chart

| | Dark skin (i=1) | Light skin | Blue sky | Foliage | Blue flower | Bluish green |
|---|-----------------|---------------|--------------|-----------|--------------|---------------|
| R | 98 | 206 | 85 | 77 | 129 | 114 |
| G | 56 | 142 | 112 | 102 | 118 | 199 |
| B | 45 | 123 | 161 | 46 | 185 | 178 |
| | Orange | Purplish blue | Moderate red | Purple | Yellow green | Orange yellow |
| R | 219 | 56 | 211 | 76 | 160 | 230 |
| G | 104 | 69 | 67 | 39 | 193 | 162 |
| B | 24 | 174 | 87 | 86 | 58 | 29 |
| | Blue | Green | Red | Yellow | Magenta | Cyan |
| R | 26 | 72 | 197 | 241 | 207 | 35 |
| G | 32 | 148 | 27 | 212 | 62 | 126 |
| B | 145 | 65 | 37 | 36 | 151 | 172 |
| | White | Neutral 8 | Neutral 6.5 | Neutral 5 | Neutral 3.5 | Black |
| R | 240 | 206 | 155 | 110 | 63 | 22 |
| G | 240 | 206 | 155 | 110 | 63 | 22 |
| B | 240 | 206 | 155 | 110 | 63 | 22 |

Product Specification

Dimension of viewing angle range.

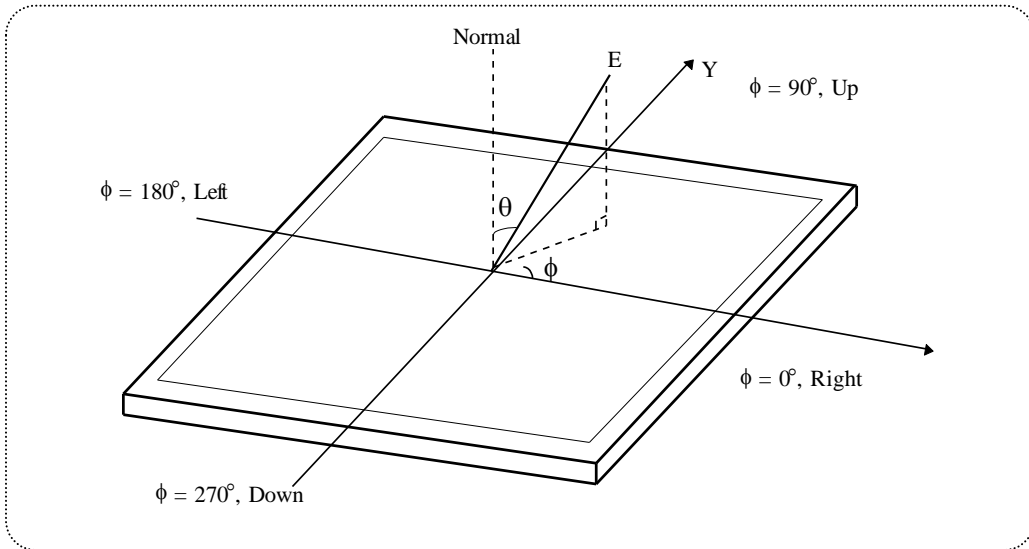

FIG.10 Viewing angle

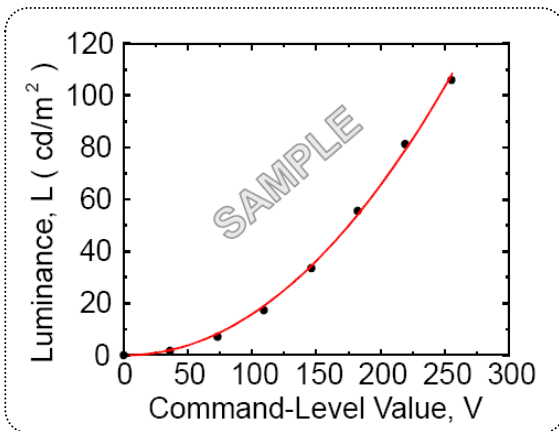

FIG.11 Sample Luminance vs. gray scale (using a 256 bit gray scale)

$$L = aV^r + L_b$$

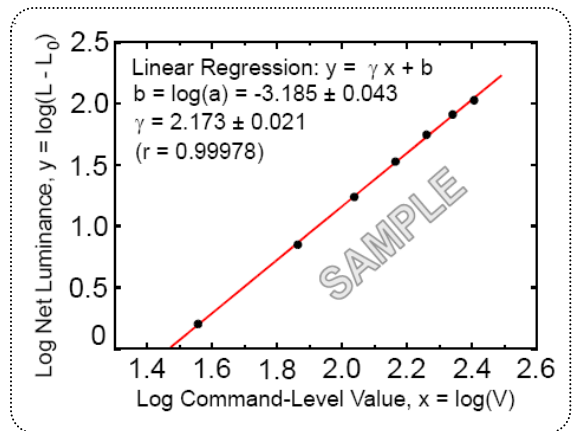

FIG.12 Sample Log-log plot of luminance vs. gray scale

$$\log(L - L_b) = r \log(V) + \log(a)$$

Here the Parameter a and γ relate the signal level V to the luminance L .
The GAMMA we calculate from the log-log representation (FIG.11)

Product Specification
Table 9. Gray Scale Specification

| Gray Level | Relative Luminance [%] (Typ.) |
|------------|-------------------------------|
| 0 | 0.10 |
| 15 | 0.30 |
| 31 | 1.08 |
| 47 | 2.50 |
| 63 | 4.72 |
| 79 | 7.70 |
| 95 | 11.49 |
| 111 | 16.20 |
| 127 | 21.66 |
| 143 | 28.20 |
| 159 | 35.45 |
| 175 | 43.80 |
| 191 | 53.00 |
| 207 | 63.30 |
| 223 | 74.48 |
| 239 | 86.80 |
| 255 | 100 |

Product Specification

5. Mechanical Characteristics

The contents provide general mechanical characteristics. In addition the figures in the next page are detailed mechanical drawing of the LCD.

| | | |
|---------------------|---|---------|
| Outline Dimension | Horizontal | 546.4mm |
| | Vertical | 352.0mm |
| | Depth | 11.7 mm |
| Bezel Area | Horizontal | 522.4mm |
| | Vertical | 328.0mm |
| Active Display Area | Horizontal | 518.4mm |
| | Vertical | 324.0mm |
| Weight | Typ : TBD g , Max : TBD g | |
| Surface Treatment | Anti-Glare treatment of the front polarizer (Haze25%, 3H) | |

Notes : Please refer to a mechanic drawing in terms of tolerance at the next page.

Product Specification

<FRONT VIEW>

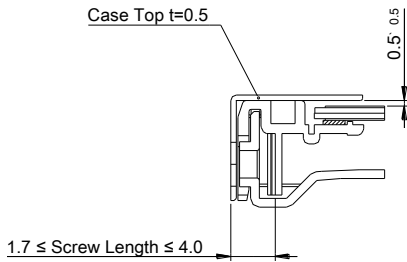
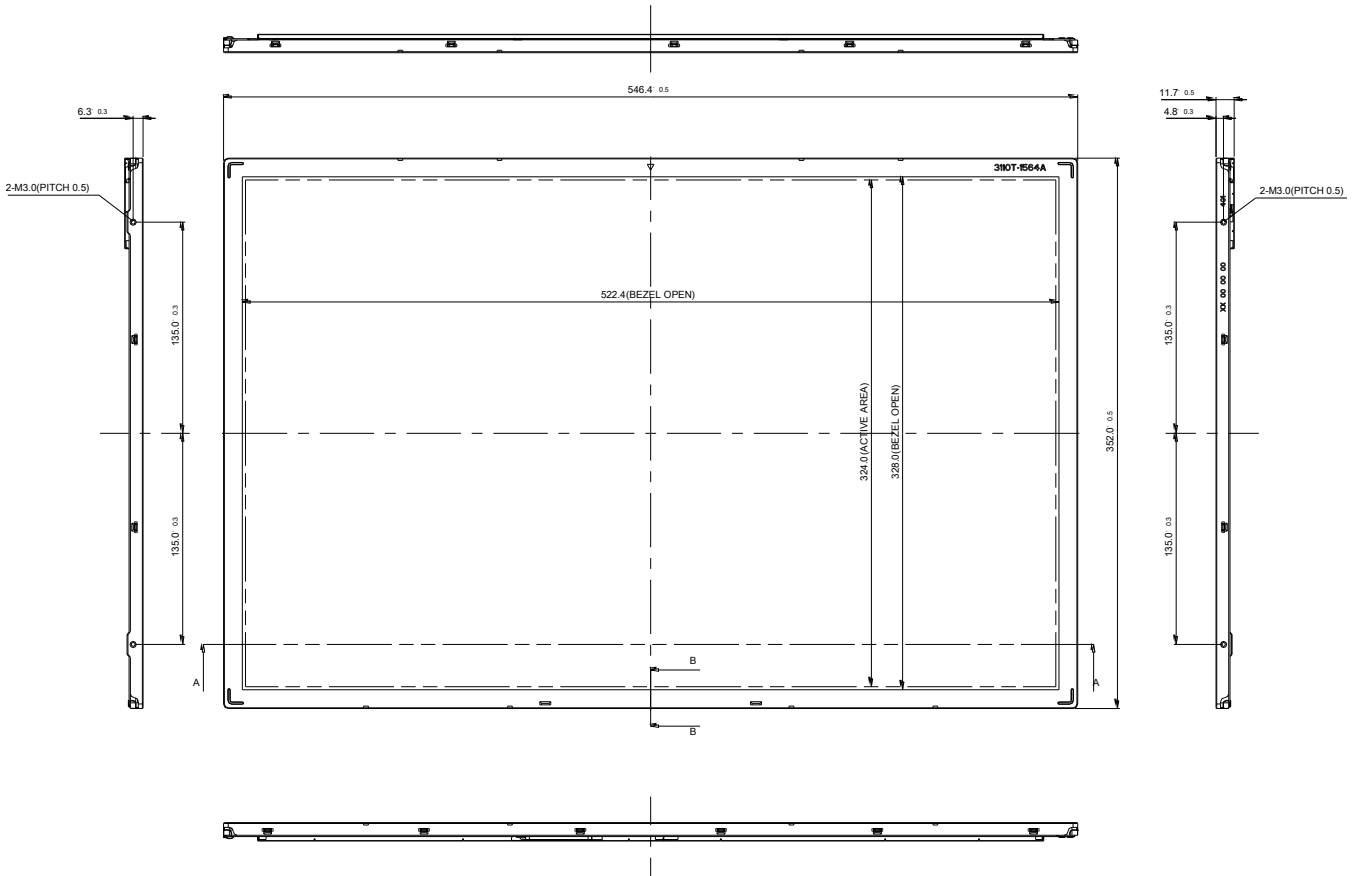

SECTION A-A
SCALE 2/1

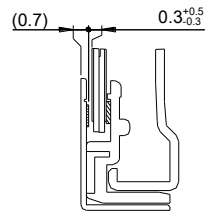
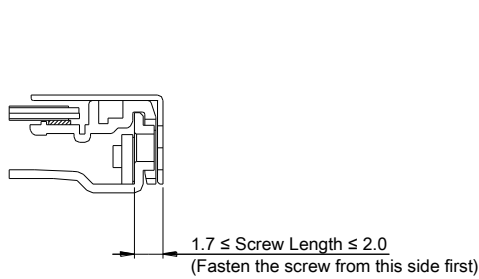

SECTION B-B
SCALE 2/1

Product Specification

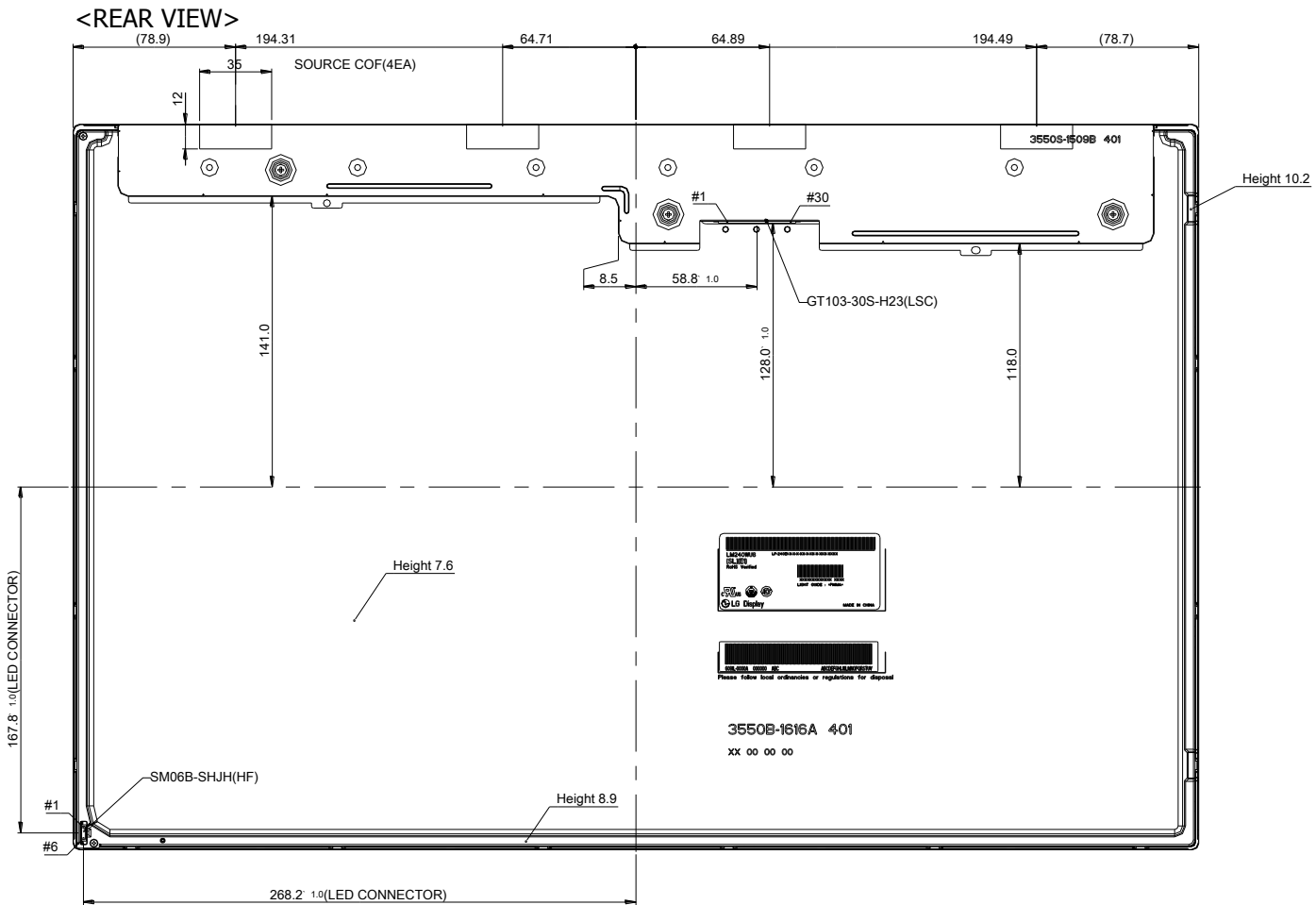

Notes

1. Unspecified tolerances are to be ± 0.5
2. Tilt and partial disposition tolerance of display area are as following.
 - (1) Y-direction : $|A-B| \leq 1.4$
 - (2) X-direction : $|C-D| \leq 1.4$
3. Torque of User Hole(Mount) : 3.0 ~4.0kgf.cm
4. I/F Connector Specification : GT103-30S-H23(LSC)
5. LED Connector Specification : JST, SM06B-SHJH(HF)
6. The COF area is weak & sensitive, so please don't press the COF area

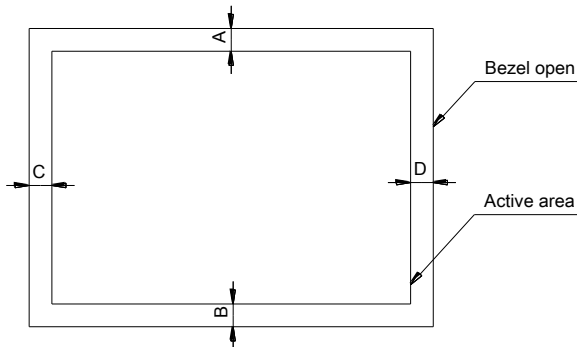

LGD Highly recommendation :

System chassis or frame should be designed to keep the IPS Panel flat as it is vulnerable to panel light-leakage caused by deformation.

Product Specification
6. Reliability

Environment test condition

| No | Test Item | Condition |
|----|--|---|
| 1 | High temperature storage test | Ta= 60°C 240h |
| 2 | Low temperature storage test | Ta= -20°C 240h |
| 3 | High temperature operation test | Ta= 50°C 50%RH 240h |
| 4 | Low temperature operation test | Ta= 0°C 240h |
| 5 | Humidity condition Operation | Ta= 40 °C ,90%RH |
| 5 | Vibration test (non-operating) | Wave form : random Vibration level : 1.0G RMS Bandwidth : 10-300Hz Duration : X,Y,Z, 10 min One time each direction |
| 6 | Shock test (non-operating) | Shock level : 100G Waveform : half sine wave, 2ms Direction : ±X, ±Y, ±Z One time each direction |
| 6 | Altitude operating storage / shipment | 0 – 10,000 feet(3,048m) 0 - 40,000 feet(12,192m) |
| 7 | Maximum Storage Humidity for 4 corner light leakage Mura. | Max 70%RH , Ta=40°C |

Note 1. Result Evaluation Criteria:

TFT-LCD panels test should take place after cooling enough at room temperature.
 In the standard condition, there should be no particular problems that may affect the display function.

7. International Standards

7-1. Safety

- a) UL 60950-1, Underwriters Laboratories Inc.
Information Technology Equipment - Safety - Part 1 : General Requirements.
- b) CAN/CSA-C22.2 No. 60950-1-07, Canadian Standards Association.
Information Technology Equipment - Safety - Part 1 : General Requirements.
- c) EN 60950-1, European Committee for Electrotechnical Standardization (CENELEC).
Information Technology Equipment - Safety - Part 1 : General Requirements.
- d) IEC 60950-1, The International Electrotechnical Commission (IEC).
Information Technology Equipment - Safety - Part 1 : General Requirements

7-2. Environment

- a) RoHS, Directive 2011/65/EU of the European Parliament and of the council of 8 June 2011

Product Specification

8. Packing

8-1. Designation of Lot Mark

a) Lot Mark

| | | | | | | | | | | | | |
|---|---|---|---|---|---|---|---|---|---|---|---|---|
| A | B | C | D | E | F | G | H | I | J | K | L | M |
|---|---|---|---|---|---|---|---|---|---|---|---|---|

A,B,C : SIZE(INCH)
E : MONTH

D : YEAR
F ~ M : SERIAL NO.

Note

1. YEAR

| | | | | | | | | | | |
|------|------|------|------|------|------|------|------|------|------|------|
| Year | 2011 | 2012 | 2013 | 2014 | 2015 | 2016 | 2017 | 2018 | 2019 | 2020 |
| Mark | A | B | C | D | E | F | G | H | J | K |

2. MONTH

| | | | | | | | | | | | | |
|-------|-----|-----|-----|-----|-----|-----|-----|-----|-----|-----|-----|-----|
| Month | Jan | Feb | Mar | Apr | May | Jun | Jul | Aug | Sep | Oct | Nov | Dec |
| Mark | 1 | 2 | 3 | 4 | 5 | 6 | 7 | 8 | 9 | A | B | C |

b) Location of Lot Mark

Serial No. is printed on the label. The label is attached to the backside of the LCD module.
This is subject to change without prior notice.

8-2. Packing Form

a) Package quantity in one box : **TBD** pcs

b) Box Size : **TBD** mm X **TBD** mm X **TBD** mm

Product Specification

9. PRECAUTIONS

Please pay attention to the followings when you use this TFT LCD module.

9-1. MOUNTING PRECAUTIONS

- (1) You must mount a module using holes arranged in rear side.
- (2) You should consider the mounting structure so that uneven force (ex. Twisted stress) is not applied to the module. And the case on which a module is mounted should have sufficient strength so that external force is not transmitted directly to the module.
- (3) Please attach the surface transparent protective plate to the surface in order to protect the polarizer. Transparent protective plate should have sufficient strength in order to resist external force.
- (4) You should adopt radiation structure to satisfy the temperature specification.
- (5) Acetic acid type and chlorine type materials for the cover case are not desirable because the former generates corrosive gas of attacking the polarizer at high temperature and the latter causes circuit break by electro-chemical reaction.
- (6) Do not touch, push or rub the exposed polarizers with glass, tweezers or anything harder than HB pencil lead. And please do not rub with dust clothes with chemical treatment. Do not touch the surface of polarizer for bare hand or greasy cloth. (Some cosmetics are detrimental to the polarizer.)
- (7) When the surface becomes dusty, please wipe gently with absorbent cotton or other soft materials like chamois soaks with petroleum benzene. Normal-hexane is recommended for cleaning the adhesives used to attach front / rear polarizers. Do not use acetone, toluene and alcohol because they cause chemical damage to the polarizer.
- (8) Wipe off saliva or water drops as soon as possible. Their long time contact with polarizer causes deformations and color fading.
- (9) Do not open the case because inside circuits do not have sufficient strength.
- (10) As The IPS panel is sensitive & slim, please recommend the metal frame of the system supports the panel by the double side-mount.

9-2. OPERATING PRECAUTIONS

- (1) The spike noise causes the mis-operation of circuits. It should be lower than following voltage :
 $V = \pm 200\text{mV}$ (Over and under shoot voltage)
- (2) Response time depends on the temperature. (In lower temperature, it becomes longer.)
- (3) Brightness depends on the temperature. (In Higher temperature, it becomes lower.)
 And in lower temperature, response time (required time that brightness is stable after turned on) becomes longer.
- (4) Be careful for condensation at sudden temperature change. Condensation makes damage to polarizer or electrical contacted parts. And after fading condensation, smear or spot will occur.
- (5) When fixed patterns are displayed for a long time, remnant image is likely to occur.
- (6) Module has high frequency circuits. Sufficient suppression to the electromagnetic interference shall be done by system manufacturers. Grounding and shielding methods may be important to minimized the interference.
- (7) Please do not give any mechanical and/or acoustical impact to LCM. Otherwise, LCM can't be operated its full characteristics perfectly.
- (8) A screw which is fastened up the steels should be a machine screw.
 (if not, it causes metallic foreign material and deal LCM a fatal blow)
- (9) Please do not set LCD on its edge.
- (10) When LCMs are used for public display defects such as Yogore, image sticking can not be guarantee.
- (11) When this forward model is used as a reverse-type model (PCB on bottom side), LGD can not guarantee any defects of LCM.
- (12) If the ITLC pin is unused, LCM can not support "Interlaced Scan Method"
- (13) Please conduct image sticking test after 2-hour aging with Rolling Pattern and normal temperature. (25~40 °C)

Product Specification

9-3. ELECTROSTATIC DISCHARGE CONTROL

Since a module is composed of electronic circuits, it is not strong to electrostatic discharge. Make certain that treatment persons are connected to ground through wrist band etc. And don't touch interface pin directly.

9-4. PRECAUTIONS FOR STRONG LIGHT EXPOSURE

Strong light exposure causes degradation of polarizer and color filter.

9-5. STORAGE

When storing modules as spares for a long time, the following precautions are necessary.

- (1) Store them in a dark place. Do not expose the module to sunlight or fluorescent light. Keep the temperature between 5°C and 35°C at normal humidity.
- (2) The polarizer surface should not come in contact with any other object.
It is recommended that they be stored in the container in which they were shipped.

9-6. HANDLING PRECAUTIONS FOR PROTECTION FILM

- (1) The protection film is attached to the bezel with a small masking tape.
When the protection film is peeled off, static electricity is generated between the film and polarizer. This should be peeled off slowly and carefully by people who are electrically grounded and with well ion-blown equipment or in such a condition, etc.
- (2) When the module with protection film attached is stored for a long time, sometimes there remains a very small amount of glue still on the bezel after the protection film is peeled off.
- (3) You can remove the glue easily. When the glue remains on the bezel surface or its vestige is recognized, please wipe them off with absorbent cotton waste or other soft material like chamois soaked with normal-hexane.